

The Cycle Analyst

Version 2.2

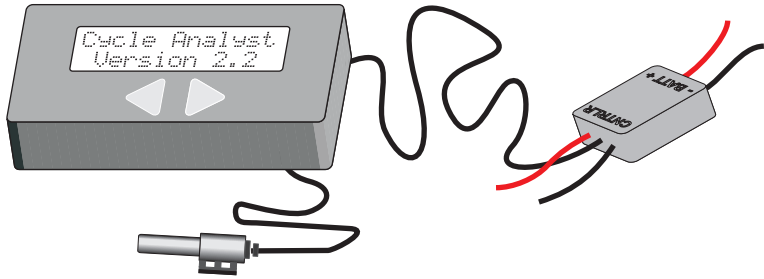

User Manual

The Cycle Analyst 2.2 User Manual

Grin Technologies Ltd.
4570 Main Street
Vancouver, BC, Canada
V5V 3R5

ph: (604) 569-0902
email: info@ebikes.ca
web: <http://www.ebikes.ca>

Author and Illustrator: *Justin Lemire-Elmore*
Copyright © 2010

Table of Contents

1.	Basic Usage	3
2.	Device Summary	4
3.	Installation	5
4.	Display Information	7
5.	Additional Resetting Options	9
6.	Setup Menu	10
7.	Using the Limiting Features	12
8.	Advanced Setup Menu	14
9.	Using Advanced Features	18
10.	Operation in Wet and Cold Conditions . .	20
11.	Circuitboard Connections	21
12.	Specifications	22

Congratulations on your purchase of a Cycle Analyst, the first digital dashboard and battery monitor designed to the specific requirements of electric bicycles, scooters, and other small electric vehicles. This device measures the energy consumption and speed of a vehicle and displays this information and related statistics on an easy-to-read backlit LCD screen. When appropriately wired to a motor controller, it is also capable of imposing a custom speed, current, or low voltage limit by regulating the throttle signal. We hope that you find it a useful accessory that optimizes the experience of your electric vehicle.

1. Basic Usage

The Cycle Analyst will turn on automatically when more than 15V appears across the circuit, and will turn off when this voltage is removed. The default screen shows five pieces of information that are most relevant to the rider. This includes three instantaneous quantities: the voltage of the battery pack, the power output in watts, and the speed of the vehicle; as well as two accumulated quantities: trip distance and net amp-hours (Ah) from the battery.

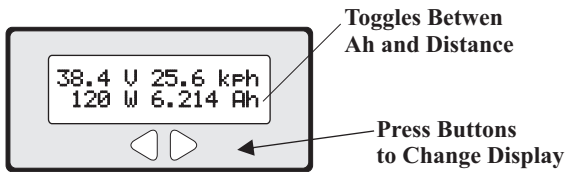

A quick left or right press of the button will scroll through other display screens of interest, while holding the right button will reset trip statistics. The second display shows just the electrical information of the battery pack, including the current in amps.



Additional clicks of the button scroll through a total of seven display screens, which are discussed in detail in **section 4**.

1.1 As a Fuel Gauge

Amp-hours (Ah) are the 'fuel' equivalent of a battery pack, but rather than behaving like a fuel gauge and estimating how much fuel is left, the Cycle Analyst instead tells you exactly how much you have used, starting from 0 and counting upwards. For example, if you have an 8 Ah battery pack, and the Cycle Analyst shows 6.1 amp-hours consumed, you would know there are just under 2 Ah remaining in the battery. This will become quite intuitive after a few rides, and you will be able to accurately gauge when the pack will run flat.

1.2 Resetting

After you have recharged the battery pack, you should reset the trip statistics (Ah, Distance, and Time) to clear them all to zero. This is done by pressing and holding the right button for 1 second, until the message "Reset" shows up across the display.

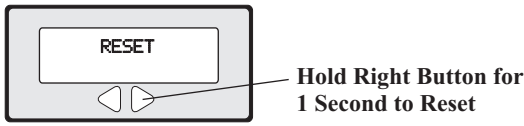

1.3 Saving

The Cycle Analyst will automatically save all the statistics when power from the battery pack is cut out. This allows you to turn off the vehicle at any time and turn it on later without losing data.

2. Device Summary

Like most electric monitoring devices, the Cycle Analyst measures the battery current in amps by amplifying the small voltage produced when current is made to flow across a shunt resistor.

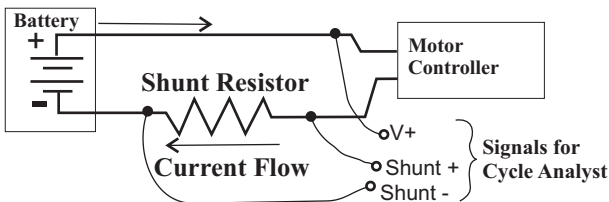

This shunt resistor must be wired in series with the negative lead of the battery pack. The power to run the Cycle Analyst then comes from the connection to the positive lead of the battery.

The Stand Alone Cycle Analyst (CA-SA) includes a molded shunt capable of 45 amps of continuous current (100 amps peak) while the Direct Plug-in models (CA-DP or -DPS) requires access to the shunt resistor inside your motor controller. The High Current model (CA-HC) is supplied with terminals to connect to a larger user-supplied shunt.

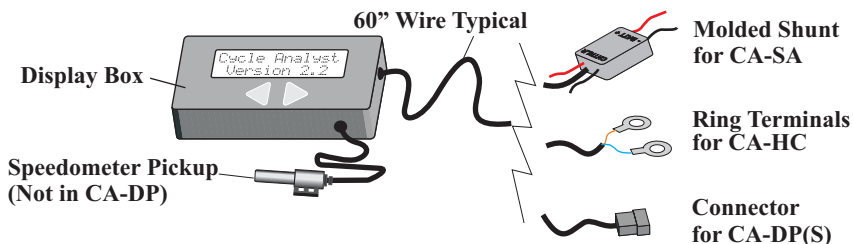

The Cycle Analyst picks up the vehicle speed information using either a spoke magnet, or in the case of the CA-DP device, through the hall sensor signals from a brushless motor controller.

3. Installation

The Cycle Analyst display box comes with a mounting bracket for installation on the handlebar of your bicycle. This bracket can rotate in two axis to adjust the display position. Use rubber shims as required around the tube if the clamp diameter is too large for your bar.

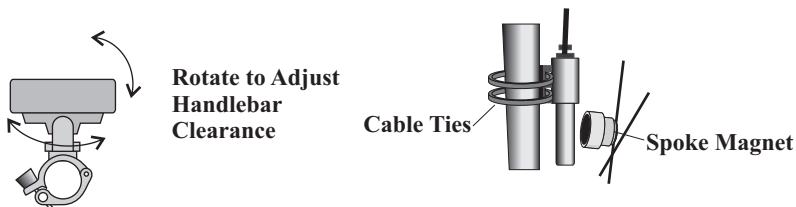

In the case of the CA-SA, CA-DPS, and CA-HC models, there is also a speedometer pickup cable and spoke magnet. The pickup attaches to the fork with two cable ties, and must be mounted to pass within 2mm of the magnet for the speed readings to register. For systems like scooters or motorcycles that don't have spoked rims, a standard magnet can be attached with epoxy to a suitable location on the wheel.

The remaining installation details depend on the model:

3.1 *Wiring of the CA-DP(S)*

With the Direct Plug models, simply plug the 6-pin connector of the CA into the motor controller. Because there are large voltages present through this connector, it is a good idea to protect the pins with dielectric grease, particularly if it will be exposed to wet conditions.

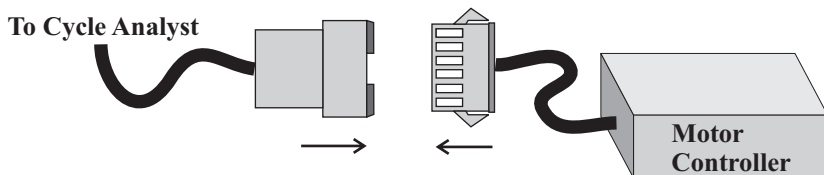

3.2 *Wiring of the CA-SA*

With the Stand Alone version, wire the molded shunt in between your battery and the motor controller. This is most conveniently done by attaching connectors on the shunt leads which match your battery connectors. If you have a switch in the system, it is best to wire the shunt after the switch so that the Cycle Analyst powers down.

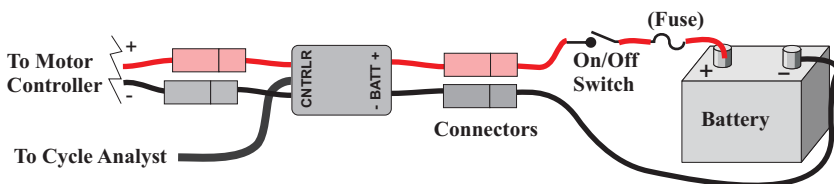

3.3 *Wiring of the CA-HC*

The High Current model attaches to a 3rd party shunt resistor and the positive battery lead. The shunt must be connected to the ground side of the battery; connection of the shunt to V+ can damage the circuitry:

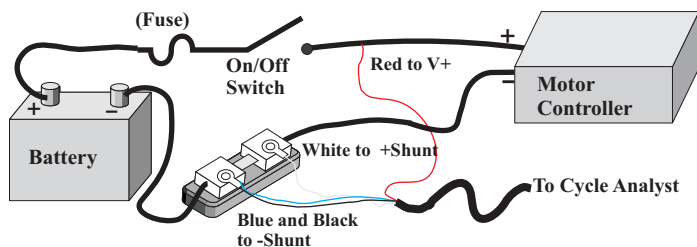

4. Display Information

In addition to the screens discussed in **section 1**, there are 5 others that show a range of statistical information relating to the energy use of your vehicle.

4.1 Display Screen #3 - Power Information

Watt-hrs: This is a measure of the total energy that has been pulled out of the battery pack. One watt-hour is 1/1000th of a kWh and slightly less than one food calorie. To a first approximation, the watt-hours available from a battery should be equal to the voltage of the pack multiplied by its amp-hours, but it will typically be less than this because of voltage droop caused by large current draw. Notice that only the positive watt-hours pulled from the pack are recorded. During regenerative braking when the watts are negative, the watt-hours value does not decrease.

Wh/km or Wh/mi: The watt-hours used per unit of distance travelled is a measure of the average energy efficiency of your vehicle. With this figure, you can readily quantify how different riding styles impact your range and predict with high accuracy the expected travel distance with any particular battery pack.

The Wh/km or Wh/mi figure is calculated taking into account current that may have flowed back into the battery pack from regenerative braking. The actual formula used is:

$$\frac{\text{Wh}}{\text{Dist}} = \text{Wh} \left(\frac{\text{FwdAh} - \text{RegenAh}}{\text{FwdAh}} \right) \frac{1}{\text{Dist}}$$

In order to reduce computational round-off errors, the figure only displays after a total distance of 0.5 km or mi has been travelled.

4.2 Display Screen #4 - Regenerative Braking

The next screen shows information that pertains to negative current, that is current flowing into the battery pack.

% Regen: The percent regen indicates by how much your range was extended as a result of energy returned to the battery from regenerative current. Most direct drive vehicles that do not have

explicit regen braking can still produce negative current when they are driven at high speeds. As well, vehicles with a freewheel in the drive could regenerate for brief periods from the energy stored in the motor's inertia. The formula used for computing this percentage is:

$$\% \text{Regen} = \frac{\text{RegenAh}}{\text{FwdAh} - \text{RegenAh}} \times 100$$

Fwd Ah and Regen Ah : The actual forward amp hours and regen (negative) amps hours to the nearest 0.0001 Ah alternate on the right side of the screen. The net amp-hours shown on the main display is the difference between these two.

4.3 Display Screen #5 - Peak Statistics

The peak electrical statistics yield information that is useful to understanding the electrical limits that the battery is subject to.

Amin: Peak negative or regen current that was captured by the meter.

Amax: Maximum amperage that was drawn from the battery.

Vmin: The voltage of a battery pack will sag, sometimes considerably, when it is under heavy load. Vmin is a local minimum measurement that shows by how much your pack's voltage droops. Typically Vmin and Amax occur at the same point, and the maximum power draw can be computed from Vmin*Amax.

4.4 Display Screen #6 - Speeds and Time

Smax and **Savg:** The maximum and average speed of the vehicle in the programmed units of km/hr or mi/hr.

0h00m00s: This is the trip time in hours, minutes, and seconds. It counts only the time that the vehicle is in motion, and stops incrementing once the speed falls to zero.

4.4 Display Screen #7 - Lifecycle Statistics

The final display screen provides the lifetime information of the battery pack. These figures are especially useful in computing the lifecycle costs of the vehicle and comparing the economics of different battery chemistries. This display is not shown when the vehicle is in motion.

Cycl: The cycles value increments when the meter is reset. Provided that the meter is reset each time the battery is charged then this will indicate the number of charge and discharge cycles on the pack. In order to prevent false cycle counts from cases where frequent resetting is performed, the value is only incremented if more than 1.6 amp-hours was drawn at the time of the reset.

TotAh: The total battery amp-hours is a running sum of battery use over its life to the nearest 1Ah.

TotMi or **TotKm:** This is the odometer function, showing the total distance that has been travelled on the battery pack.

5. Additional Resetting Options

In addition to a regular reset to clear the trip distance, time, and amp-hour data (see **Section 1.2**), there are two other reset possibilities.

5.1 *Peak Reset*

In some instances for diagnostic and performance testing, it is desirable to clear only the peak statistics (Amax, Amin, Vmin, and Smax) without resetting anything else. This can be accomplished by holding the right reset button when the display is showing Amin, Amax, and Vmin. The message "PEAK STATS RESET" will appear on the screen and only the previously mentioned values will be cleared.

5.2 *Full Reset*

When it is time to switch battery packs, then the battery cycle count, lifetime amp-hours, and total distance can be zeroed by performing a full reset on the system. This is accomplished by continuing to hold the button for 6 seconds after "RESET" is displayed. The message "FULL RESET" will appear to indicate that all stored data has been cleared from memory. Notice that a Full Reset does not restore any of the gain or calibration values that may have been changed in the setup menu. The default values for these are shown in **Section 8**.

6. Setup Menu

There are many setup options that can be accessed at any time by pressing and holding down the left button. Alternately, if only a single button interface is desired, then holding the right button while power is applied to the device will also enter the setup menu.

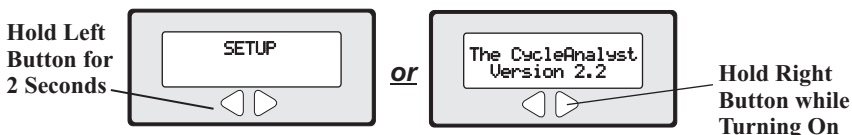

Once entered, navigate through the setup options in the following manner:

Press either button briefly to toggle the information at hand.
(like up and down arrow keys)

Hold the **right** button down for one second to save that information, or to enter a submenu. (like an enter key)

6.1 Select your units:

The first setup option is to choose between displaying in miles or kilometers. If you want to change the setting, hold the right button until **_OK** appears on the screen. Then pressing either button will toggle between mi or km, and holding the right button again will save your selection and move to the next item.

6.2 Setting the wheel size

After units are input, you will be presented with 'Set Wheel' to input the circumference of the tire. To change this to your actual wheel size, hold the right button until **_OK** appears in the bottom right hand corner. Then the first digit will flash, and you can cycle it through 0-9 with the left and right buttons. When the correct value appears, hold down the right button to save it and move on to the next digit.



The following table is a convenient reference on the circumference of several popular bicycle tire sizes. For highest accuracy, measure the actual circumference directly with a tape measure or similar technique.

Tire Size	Circumference	Tire Size	Circumference
16 x 1.50	1185	26 x 1.25	1953
16 x 1 3/8	1282	26 x 1-1/8	1970
20 x 1.75	1515	26 x 1-3/8	2068
20 x 1-3/8	1615	26 x 1-1/2	2100
24 x 1-1/8	1795	26 x 1.50	2010
24 x 1-1/4	1905	700c x 23	2097
24 x 1.75	1890	700c x 28	2136
24 x 2.00	1925	700c x 32	2155
24 x 2.125	1965	700c x 38	2180

The next three setup items only matter to Cycle Analysts that have been wired with the throttle over-ride signal connected to the motor controller. The Direct Plug-in models already have this appropriately connected, but the Stand Alone and High Current version require additional wiring for these settings to have any effect.

6.3 *Speed Limit*

Set the maximum speed beyond which the motor controller will cease to provide useful output power. The Cycle Analyst will vary the throttle signal such that the vehicle will continue to cruise at this set point speed.

6.4 *Volts Limit*

Program the low voltage rollback point for your battery pack. The Cycle Analyst will reduce power drawn from the controller in order to keep the battery voltage from dropping below this limit.

6.5 *Max Amps*

Set the upper current limit. If the Cycle Analyst senses current above this value, it will scale down the throttle appropriately to reduce the amperage draw.

6.6 Main Display

Finally, the last setup option allows the user to select whether the primary display screen shows watts or amps in the bottom left corner, depending on the user preference. The 2nd display screen will always show both quantities.

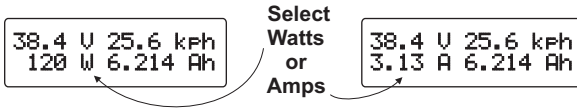

7. Using the Limiting Features

There are many situations when it is desirable to limit the amount of power that the controller is able to draw from the battery pack. For instance, you might want a current limit in order to:

- A) Protect the cells in a battery pack from delivering more than their rated amperage
- B) Extend the range of your vehicle by reducing current draw during acceleration and hill climbing
- C) Safely cycle at low current a NiMH or NiCad pack that has been sitting unused for a long period
- D) Keep the motor's power within a legally stipulated power limit

A speed limit can help make any electric bicycle abide by the legal speed caps that exist in most jurisdictions while not affecting performance below that speed. It can also be useful for extending the range or for taming a setup that is otherwise too fast for comfort, without sacrificing hill climbing torque.

The voltage limit is used primarily to prevent the battery pack from being over discharged which can be damaging to the cells. Typically, you would set it between 29 to 31V for a 36V pack, and between 39 to 41V for a 48V pack.

7.1 How the feedback works

To understand how the limiting features work, just imagine how you would operate the throttle manually. If you are going over a desired speed limit, you would back off the throttle. If the vehicle then reached a hill and started to slow down from your target speed, you would further engage the throttle, thus continuously adjusting the throttle position to keep at your desired velocity.

The Cycle Analyst behaves similarly. When it senses that any one of the limiting quantities has been exceeded, then the throttle over-ride signal starts to decrease from its default resting value (usually between 4 to 5V, determined by $I_{TermMax}$). A simple circuit is required so that the controller only sees the lower value of the throttle signal or the Cycle Analyst signal. This is generally achieved with a diode as follows:

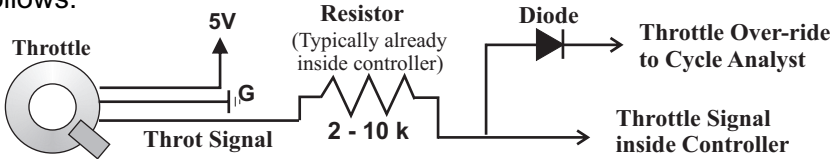

There are various setup options which control the speed at which the Cycle Analyst responds to these signals. If the settings are too fast, then the control can be twitchy or oscillate around the desired value, while gain settings that are too low will cause a long lag time before the limiting kicks in.

7.2 PI Controller

Each of the three limiting features is implemented as a digital Proportional/Integral (PI) controller. The actual output for speed regulation is computed as follows:

$$I_{Term} = \text{Previous } I_{Term} + \text{IntSGain} * (\text{Set Speed} - \text{Actual Speed})$$

$$\text{Clamp: } I_{TermMin} < I_{Term} < I_{TermMax}$$

$$\text{Override} = I_{Term} + \text{PSGain} * (\text{Set Speed} - \text{Actual Speed})$$

Similar values are calculated with the current limit, and low voltage limit, and the smallest of the three over-ride terms is output as a voltage. If this output is less than the user's throttle voltage, then it is the CycleAnalyst which is ultimately controlling the vehicle.

7.3 Tuning the feedback

The ability of the Cycle Analyst to limit the speed, current, or low voltage in a fast yet smooth manner depends on setting the appropriate Gain terms for the feedback loop. The default values work well for ebike setups in the 300-600 watt power range. For more powerful systems, they will usually lead to the vehicle oscillating around the programmed set point rather than holding steady. In this case, it is necessary to tone down the appropriate feedback gains in the advanced setup menu.

8. Advanced Setup Menu

The advanced setup menu is accessed by pressing and holding the button when the message 'advanced' shows up at the end of the regular setup menu, and allows for setting less frequently changed parameters.

8.1 Range Mode

There are two mode settings that are available to accommodate the wide scope of electric vehicles. The high range mode should be used with shunts that are under 1mOhm, such as in electric motorcycles and small electric cars that draw hundreds of amps. In this mode, the Cycle Analyst will display current to the nearest 0.1 A and will show power in kW. For shunts that are over 1 mOhm but less than 10 mOhm, the LowRange mode must be selected. This will increase the resolution to 0.01 A.

8.2 Averaging

In an electric vehicle, the current and voltage can fluctuate rapidly under normal use, making the instantaneous values difficult to read. These values are averaged before display. Short averaging times allow you to get a better real time feel for the power fluctuations, while longer averaging times produce a stable reading that is easier to record. The range is 1-7, which correlates to 0.025 seconds to 1.6 seconds between display updates. The default setting is 5 (0.4 sec).

8.3 Set Rshunt

The Cycle Analyst is calibrated by programming a resistance value for the current sensing shunt. If you are using a known shunt resistor, then as a first estimate this value can be programmed directly in mOhm. This will usually get the meter accurate to within 3%. For highest accuracy, the shunt value should be calibrated so that the displayed amperage matches that of a known current reference, which may not be precisely the same as the mOhm rating on the resistor. If the current is reading too low then the shunt resistance value needs to be decreased, and vice versa. Allowed values are:

- 0.763 to 9.999 mOhm in Low Range Mode
- 0.0763 to 0.9999 mOhm in High Range Mode

8.4 Zero Amps

Over time and with temperature fluctuations, it is possible for the zero point to drift, such that even when no current is flowing through the shunt a small number (like 0.03A) is displayed. This can be reset to zero by holding down the button after the 'zero amps' screen until the `_OK` flashes on the bottom right. Note though that many shunt materials, especially the wire shunts used in motor controllers, are prone to generating thermoelectric voltage for a short while after being used. This has the effect of producing what appears to be a lingering current that slowly decays back to zero, and it should not be confused for a current offset in the Cycle Analyst.

8.5 Volts Sense

Changing this value will change the calibration for the voltage that gets displayed on the screen. The circuitboard uses a ~22:1 resistive voltage divider ratio, so that each volt that is read by the analog to digital converter is scaled by a factor of approximately 23 before being displayed on the screen. This value can be changed either for calibration or to display a voltage that is proportionally higher or lower than the voltage powering the Cycle Analyst.

8.6 Set#Poles

For Direct Plug-in units, this should be set to the number of hall effect transitions per rotation of the wheel. Crystalyte 400 series hubs have 8, the 5300 series hubs have 12, and the Nine Continent 205 series motors have 23 poles. For units that use a speedometer sensor and spoke magnet, #poles should be set to 1, unless you have multiple magnets on the wheel. The #poles setting can range from 1-99.

8.7 PSGain

This is the Proportional Speed Gain for the over-ride output. It can decrease the response time and reduce overshooting the set point speed, but at the risk of causing rapid vibrations if it is too high. The range can vary from 0 to 0.99 V/kph or V/mph. **Default = 0.08**

8.8 *IntSGain*

This value determines how rapidly the over-ride output will ramp down when the speed of the vehicle exceeds the limit speed. Increasing this value will speed up the response time for the speed control, but at the risk of causing oscillations. Too low of a value will allow considerable overshoot of the speed limit. The gain value can range from 0 to 999, and the scaling is currently arbitrary. **Default = 200**

8.9 *IntAGain*

This value determines how rapidly the over-ride output will ramp down when the current from the battery pack exceeds the programmed current limit. Too low of a value will result in considerable overshooting of the set point current, while too large of a gain will cause the controller to oscillate above and below the limit. The range of allowable values is from 0 to 999. **Default = 300**

8.10 *IntVGain*

This value determines how rapidly the over-ride output signal will scale down when the pack voltage falls below the set low voltage cutout. The range of allowable values is from 0 to 999, and the scaling is arbitrary. **Default = 800**

8.11 *ITermMax*

This puts an upper limit on how high the throttle over-ride will drift upwards when none of the limit values are being exceeded. Ideally this value is set to the voltage that is considered full throttle by the controller. For hall effect throttles, full power occurs at about 4V, and limiting the ITerm to this value will speed up the response time of the limiting features. Allowable values are from 0 to 4.99V. **Default = 3.79V**

8.12 *ITermMin*

This value imposes a lower bound on how low the throttle over-ride can drift downwards when one of the limiting values is being exceeded. By preventing the over-ride signal from going all the way to 0V, you can decrease the recovery time for the signal to go back upwards. Range is from 0 to 4.99V, and must be less than ItermMax. **Default = 0.49V**

8.13 Max Throttle

This value puts a maximum cap on the throttle output signal. It can be used to simulate a lower speed motor by simply clamping the throttle signal to a value between 0 to 5V. Be aware that the majority of hall effect throttles only operate from 1V to 4V, and so the desired setting to reduce the speed would fall in this range less the diode voltage drop.

8.14 Set Ratio

This is the amplification ratio between the high gain and low gain current amplifiers on the circuitboard. It is usually around 0.1, is factory calibrated, and should not be changed.

8.15 Serial Output

This allows you to select between either a 1Hz or a 5Hz transmission rate on the Tx serial data output pad. 1Hz is good for general purpose datalogging, while the faster 5Hz rate can be useful for dynamic analysis of vehicle performance. **Default = 1Hz**

8.16 Set TotDist, Set TotAhrs, Set TotCyc

The next three screens enable you to preload or edit your life cycle usage statistics: the total odometer distance, the total amp-hours you have taken from the pack, and the total number of discharge and charge cycles on the battery.

8.17 Aux Voltage Function

This allows you to set the function of the auxiliary input voltage line (Pad Vi) on the Cycle Analyst circuit board. You can choose whether this line is ignored (default) or if it is used for on-the-fly regulation of either the speed limit or the current limit via a variable voltage source.

8.18 Aux Threshold

The auxiliary voltage input is scaled over a 3V input range to be compatible with hall effect throttles. You can set the threshold where this voltage kicks in. For instance, if the threshold is 0V, then the input range is 0-3V. If the threshold is set to 1V, then the input range from zero to full scale is 1-4V, matching the range of most ebike throttles.

9. Using Advanced Features

There are several advanced features on the Cycle Analyst, but making use of these requires soldering to the circuit board. Incorrect wiring can easily damage the unit and it is only recommended for those who are familiar and comfortable with electronics.

9.1 Using the Data Output (V2.1 and beyond)

The pad labeled “Tx” contains a serial data stream with the current stats of the vehicle. The format is tab-delimited ASCII text at a 9600 baud rate. After power-up, the CA outputs a header line, and then at a rate of once a second or 5 times a second (see section 8.15) it transmits the amp-hours, voltage, amperage, speed, and distance as shown here:

Ah	V	A	S	D3
3.296	47.62	10.04	15.32	8.9132
3.299	47.49	13.22	16.41	8.9175
3.302	47.43	13.45	17.30	8.9220
3.306	47.85	6.02	17.52	8.9268
3.308	49.36	-1.43	17.17	8.9317
3.307	49.55	-3.69	16.05	8.9365
:	:	:	:	:

The data is at 0-5V CMOS voltage levels, making it easy to interface directly to other microcontrollers. In order to log the data to a regular computer or laptop, it is necessary to either level shift the signal to be compatible with RS-232 voltages and run it to the computer serial port, or process the signal and connect it via USB, IrDA, BlueTooth, or other standard.

For running into a computer serial port, a MAX232 or a similar RS-232 driver chip can be powered from the **5V*** and **G** pads. The resulting datastream can be seen and saved with HyperTerminal or other terminal software. The following diagram shows a typical setup:

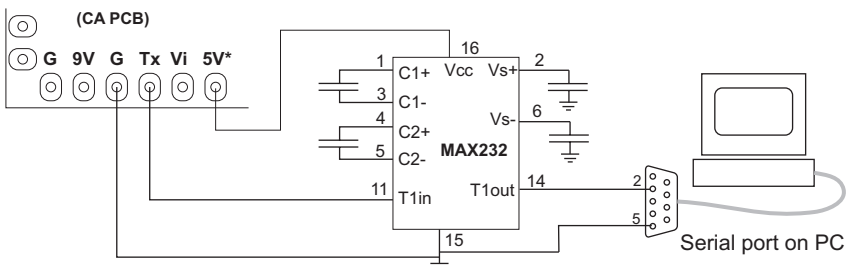

9.2 On-the-fly Current or Speed Limit (V2.11 and later)

There are situations where it may be desirable to adjust the speed or current limit of the Cycle Analyst without having to change the settings in the setup menu. This can be accomplished by wiring a potentiometer such that it sends a voltage signal to the **Vi** pad:

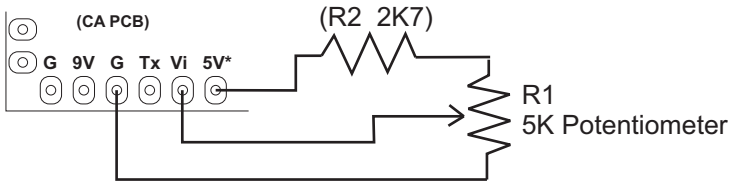

The optional resistor R2 is used to reduce the potentiometer wiper range from 0-5V to just 0-3V so that the entire turn range is utilized. In the advanced setup menu, you can select whether this voltage regulates the current limit or the speed limit, and it will scale the limit between 0 and the speed/current limit programmed in the setup menu.

9.3 Current Throttle or Cruise Control (V2.2 and later)

In other cases, it may be advantageous to use the Cycle Analyst to directly regulate the motor controller rather than just limiting the power via a throttle over-ride function. The example below shows how to wire up a “current throttle”, such that the regular throttle signal is intercepted by the Cycle Analyst, which takes this as the command current. The Cycle Analyst then sends it’s own throttle signal along to the motor controller.

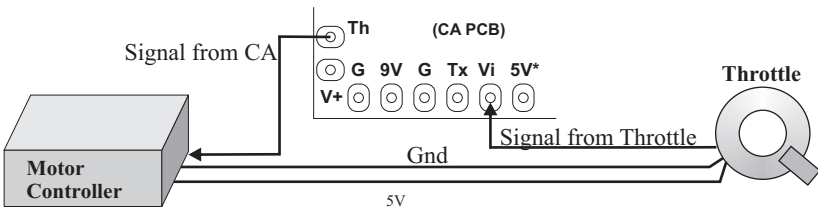

In this manner, if full throttle is set to be 20 amps, then by riding half throttle, you could ensure exactly 10 amps are drawn from the battery regardless of the vehicle speed, giving the user more direct control over their power usage. Similar setups can be used to implement accurate cruise control systems. Note that it is essential to set the AuxVoltage input (see 8.17) to either the current or speed limit first, otherwise the system will take off at full power when turned on.

9.4 Firmware Programming

The set of 5 header pads on the bottom right of the PCB is used for programming the microchip. The pinout is the same as recommended by Microchip's "In-Circuit Serial Programming™ (ICSP™) Guide" and is compatible with most in-circuit serial programmers. We usually recommend the Microchip PICkit2, but many other programming devices will work as well. The firmware can be flashed either with the Cycle Analyst powered up, or from the 5V supply of the programming device.

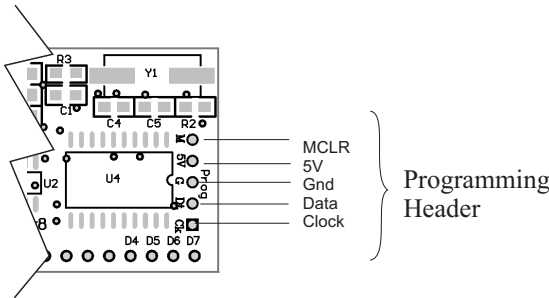

10. Operation in Wet and Cold Conditions

The Cycle Analyst enclosure contains a clear sealed window to protect the circuitboard and LCD from water exposure. There is no problem using the meter in light rain. However, in cases of prolonged exposure to wet conditions, it is possible for moisture to enter the box through the back cover which is not sealed. This can cause the window to fog up in cold conditions and render the display difficult to read. Should this occur, simply remove the back cover so that the moisture can escape and let the unit dry thoroughly indoors. When it is reassembled, you may consider using a sealant around the lip and screw holes to render the box fully waterproof.

The LCD screen is specified to operate between -10°C to 50°C . At the colder end of the temperature range, the response time of the LCD segments is slow, and so rapidly changing digits and screen changes will appear as a blur. The underlying operation of the internal circuitry is unaffected.

11. Circuitboard Connections

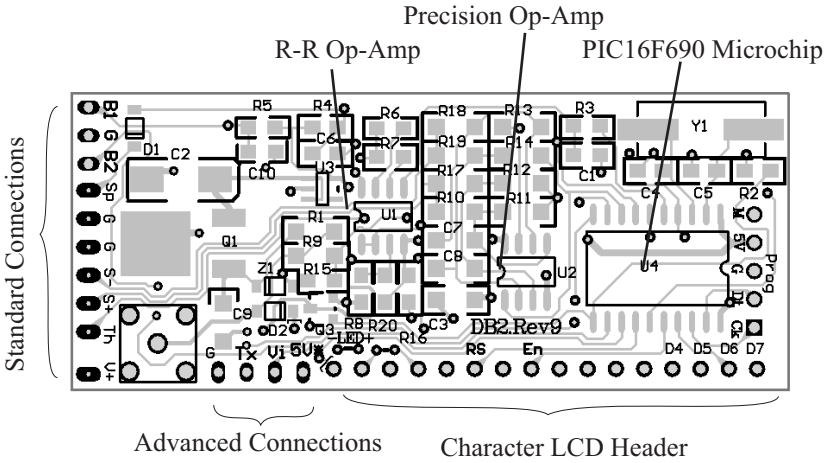

Standard Connections:

- B2** = Optional 2nd button input (not implemented in V2.1 firmware)
- G** = Ground
- B1** = Primary button input
- Sp** = Speedometer pulse input. Can be either magnetic reed switch to Gnd, or a 0-5V / 0-12V hall signal from the controller
- G** = Ground (**black wire**)
- S-** = Negative side of current sense Shunt Resistor. Must be within ± 400 mV of Gnd (**blue wire**)
- S+** = Positive side of Shunt Resistor (**white wire**)
- Th** = Throttle Over-ride output, analog signal from 0-5V, buffered by R-R Op-Amp. Short out or reduce R6 if necessary to increase stiffness of output when sinking or sourcing more than 1-2 mA
- V+** = Positive lead to battery pack (**red wire**)

Advanced Connections:

- G** = Ground
- Tx** = Serial data output signal, 9600 baud, 0-5V CMOS level
- Vi** = Auxiliary input voltage, 0-5V range. Voltages above 5V may permanently damage the device
- 5V*** = 5V source, user may draw up to 5mA from this line for powering external circuits. Currents beyond 5mA can cause excessive heating of linear regulator

12. Specifications

Voltage Range	15-100V Standard, 20-200V optional
Voltage Resolution	0.1V
Current Draw	7mA
Current Range	± 200 mV/Rshunt. For instance, with a $2\text{m}\Omega$ sense resistor, the maximum current is 100 amps. With a $0.5\text{m}\Omega$ resistor, up to 400 amps, and so forth
Current Resolution	0.01A in low range mode, 0.1A in high range mode
Current Accuracy	Temperature coefficient and accuracy depend on the shunt and calibration. With pre-calibrated Stand Alone model, it is within $2\% \pm 0.06\text{A}$
Trip Ah and Wh	Up to 1999 Ah and 19999 Wh in low range mode, and 10x this in high range mode.
Trip Distance	Up to 1999 km or mi. Odometer rolls over at 99999 km or mi
Wheel Size	0 to 9999 mm
Speed Range	Up to 600 kph or mph, there is an upper limit of about 1kHz for the speed sensor input

Note that if any Ah, Wh, or Distance limits are exceeded, then the calculated values such as Wh/km and average speed will be incorrect. Be sure to reset after each battery recharge.

CA-DP Connector Pinout:

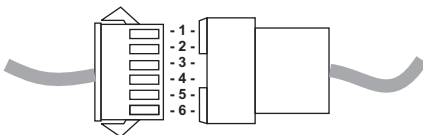

- 1 = Vbatt (Red)
- 2 = Ground (Black)
- 3 = Shunt - (Blue)
- 4 = Shunt + (White)
- 5 = Speed (Yellow)
- 6 = Throttle Over-ride (Green)