



# The Cycle Satiator Universal Charger

User Manual for V1.0 Firmware  
Rev. 1.0.X



**Grin Technologies Ltd**  
#205-950 Powell St  
Vancouver, BC, Canada  
V6A 1H9

ph: (604) 569-0902  
email: [info@ebikes.ca](mailto:info@ebikes.ca)  
web: <http://www.ebikes.ca/satiator>

*Copyright © 2017*

# IMPORTANT SAFETY INSTRUCTIONS

1. **SAVE THESE INSTRUCTIONS:** This manual contains important safety and operating instructions for battery charger Model GC360-4808.
2. Before using battery charger, read all instructions and cautionary markings on battery charger, battery, and product using battery. The power unit is to be installed so that it is not likely to be contacted by people during the charging process.
3. **CAUTION:** Risk of electric shock- connect only to properly grounded outlets. Do not expose to rain when charging. Charge only rechargeable lithium, NiMH, or sealed lead-acid batteries with correct voltage and current settings. Other battery types or incorrect settings may damage battery, with risk of fire and personal injury. Never charge a frozen battery.
4. **WARNING:** The device is not to be used by persons (including children) with reduced physical, sensory or mental capabilities, or lack of experience and knowledge, unless they have been given supervision or instruction. Children must not play with the charger.
5. **DANGER:** Do not open charger- there are no user serviceable parts inside. Only operate charger in a dry location with the battery pack located a safe distance from combustible materials. Do not leave batteries charging unattended. Only charge lithium batteries that have an onboard Battery Management System (BMS).

**FCC NOTICE:** This charger has been tested and found to comply with Part 15 of the FCC rules, which governs the emission limits for a Class B digital device. These limits offer reasonable but not guaranteed protection against electrical interference between your charger and TV's, radios, and other radio-frequency communication devices. If electrical interference is still detected, which can be confirmed by turning the charger off and on, possible corrective actions include:

- Reorienting or relocating the receiving antenna of your device
- Increasing the separate distance between the charger and receiver
- Connecting the charger into a different AC outlet circuit as the receiver
- Consulting a dealer or radio/TV technician for help

## INSTRUCTIONS IMPORTANTES CONCERNANT LA SECURITE

1. **CONSERVER CES INSTRUCTIONS:** Ce manuel contient des instructions importantes concernant la sécurité et le fonctionnement du chargeur. modèle GC360-4808
2. Avant d'utiliser ce chargeur de batterie, lire toutes les instructions et les marquages d'avertissement sur le chargeur de batterie, la batterie et le produit utilisant la batterie.
3. **AVERTISSEMENT:** Risque de décharge électrique. Connecter uniquement à des prises à la terre. Ne pas exposer à la pluie lors de la charge. Recharger uniquement des batteries rechargeables au lithium, au nimh ou au plomb-acide scellées, avec des paramètres de tension et courant adéquats. Tout autre type de batterie ou tout paramètre incorrect peut endommager la batterie et causer des risques d'incendie et blessures. Ne jamais charger une batterie gelée.
4. **ATTENTION:** Cet appareil ne doit pas être utilisé par des personnes (enfant y-compris) ayant des capacités physiques, sensorielles ou mentales réduites, ou un manque d'expérience et de connaissance, sauf s'ils ont reçu supervision ou instruction. Les enfants ne doivent pas jouer avec le chargeur.
5. **DANGER:** Ne pas ouvrir le chargeur- aucune pièce n'est réparable par l'utilisateur. Faire fonctionner uniquement dans un endroit sec avec la batterie située à une distance de sécurité suffisante de matériaux combustibles

**FCC remarque:** Ce chargeur a été testé et trouvé conforme avec la Partie 15 du règlement FCC qui gouverne les limites d'émissions pour un appareil digital de classe B. Les limites offrent une protection raisonnable mais non garantie contre les interférences électriques entre ce chargeur et les télévisions, radios, et autres appareils de communication radio à radio-fréquence. Si une interférence est tout de même détectée, ce qui peut-être confirmé en allumant et éteignant le chargeur, les possibles mesures de correction incluent:

- Réorienter ou relocaliser les antennes de réception des appareils
- Augmenter la distance de séparation entre le chargeur et récepteur
- Connecter le chargeur à une prise d'un circuit électrique différent de celui du receveur
- Consulter un revendeur ou technicien radio/tv pour obtenir de l'aide

# Table of Contents

<b>1</b>	<b><i>Basic Overview</i></b> .....	<b>5</b>
1.1	Getting Started.....	6
1.2	Setting up your First Profile.....	6
1.3	Charging Process.....	7
1.4	Terminating Charge.....	8
1.5	Additional Screens.....	9
<b>2</b>	<b><i>Satiator Setup Menu</i></b> .....	<b>10</b>
2.1	Editing the Profile List.....	11
2.2	Advanced Settings.....	14
2.3	Connect to PC.....	15
2.4	About Charger.....	16
<b>3</b>	<b><i>Charge Process with Multiple Profiles</i></b> .....	<b>16</b>
3.1	No Default Profile.....	16
3.2	With Default Profile.....	17
3.3	Default Profile Usage.....	17
<b>4</b>	<b><i>Charge Profile Details</i></b> .....	<b>18</b>
4.1	Lithium.....	18
4.2	Lead Acid (SLA).....	20
4.3	Nickel (NiCad or NiMH).....	21
<b>5</b>	<b><i>Additional Features and Details</i></b> .....	<b>23</b>
5.1	Force Start.....	23
5.2	Fault Conditions.....	24
5.3	Cell Balancing.....	25
5.4	Thermal Rollback.....	25
5.5	Exposure to Rain.....	Error! Bookmark not defined.
5.6	Orientation and Vent.....	25
5.7	Thermistor.....	26
5.8	Upgrading Firmware.....	26
<b>6</b>	<b><i>Complete Navigation Map</i></b> .....	<b>27</b>
<b>7</b>	<b><i>Specifications</i></b> .....	<b>28</b>

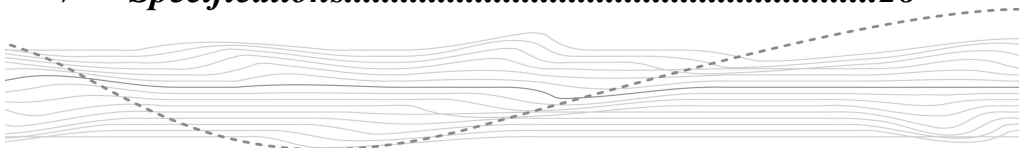

Congratulations on acquiring a Cycle Satiator universal charger, for use with all kinds of 24-48V nominal battery packs. We hope that this one device serves you and your batteries for years to come.

## 1 Basic Overview

The Satiator was designed with a compact and narrow form factor so that it could be used either as a portable stand-alone charger, or mounted to the frame of your bike/vehicle as an onboard charger. It has an AC input power port on the side, (100-240V AC), a DC output cable to connect the charger to the battery, a graphical display screen for showing the real-time charging status, and a pair of buttons to navigate the charger menus.

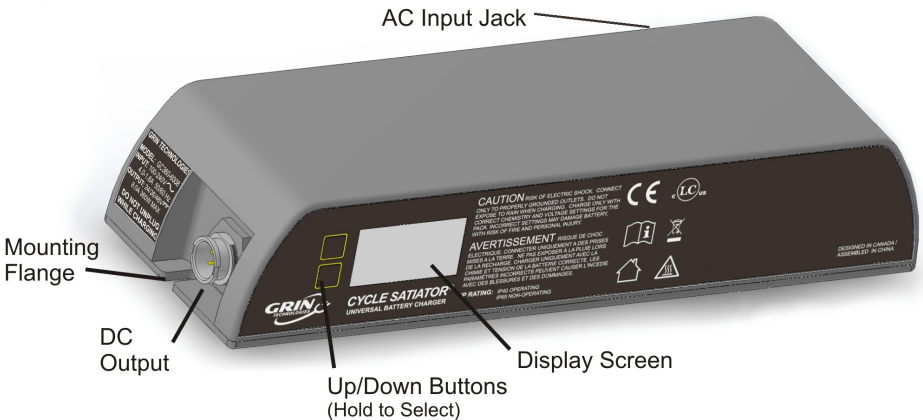
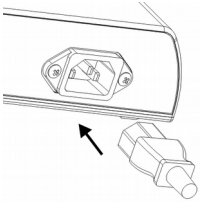

**Figure 1:** Satiator Model and Features

While most battery chargers are limited to charging one specific battery type and voltage, the Satiator is programmable so that you can choose between a number of battery charging behaviours. You could use it to charge a 24V lead acid pack one day, and a 48V lithium ebike battery the next.

This adjustability is useful. It means a separate charger is no longer needed for each of your batteries, and when you upgrade to a new pack, the Satiator can be configured to match it even if the voltage and chemistry are different. It also allows you to select between rapid charge rates for top-up convenience and conservative overnight charging to maximize battery life.

## 1.1 Getting Started



**Figure 3:** Connect AC Power to Turn On

The Satiator does not have an ON/OFF switch, so it will turn on whenever there is power present on the AC input port. The 3-pin IEC connector is the familiar standard for personal computers, and if the included cable does not match your country's outlet standard then there should be no problem finding one locally. Just be sure to use a grounded 3-pin outlet.



**Figure 2:** Splash Screen after power applied, shows Model and Firmware Version

## 1.2 Setting up your First Profile

If the Satiator was purchased by itself without a battery, then it will usually arrive out of the box without any profiles activated. Before you can use it to charge a battery, you will need to select an output appropriate for your pack. The display will say *NO PROFILES ACTIVE* after briefly showing a splash screen.

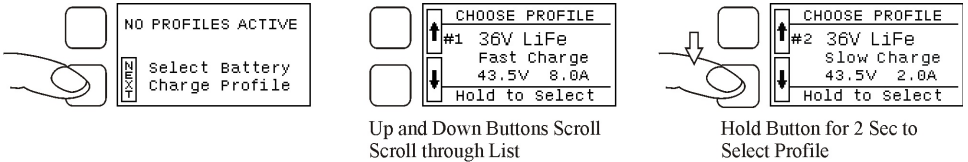

**Figure 4:** Setting up the first profile on a new Satiator device

Pressing the up or down button will let you scroll through a number of preset profiles. When you see the profile for your battery, press and hold the lower button to select it. A screen will ask you to confirm the selection.

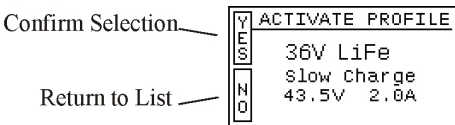

**Figure 5:** First profile confirmation

The preset profiles for the 48V model are shown in the table below and cover the majority of lithium and lead acid batteries encountered in ebike applications.

<b>Title:</b>	36V Lithium	36V Lithium	36V Lithium	36V LiFePO4	36V LiFePO4
<b>Subtitle:</b>	Fast Charge	Stnd Charge	85% Charge	Fast Charge	Stnd Charge
<b>Bulk Amps:</b>	8.0 A	4.0 A	4.0 A	8.0 A	4.0 A
<b>Full Volts:</b>	42.0 V	42.0 V	40.5 V	43.2 V	43.2 V

<b>Title:</b>	48V Lithium	48V Lithium	48V Lithium	48V LiFePO4	48V LiFePO4
<b>Subtitle:</b>	Fast Charge	Stnd Charge	85% Charge	Fast Charge	Stnd Charge
<b>Bulk Amps:</b>	7.0 A	4.0 A	4.0 A	7.0 A	4.0 A
<b>Full Volts:</b>	54.5 V	54.5 V	52.6 V	57.6 V	57.6 V

<b>Title:</b>	52V Lithium	52V Lithium	52V Lithium	24V SLA	36V SLA	48V SLA
<b>Subtitle:</b>	Fast Charge	Stnd Charge	85% Charge	Fast Charge	Stnd Charge	Stnd Charge
<b>Bulk Amps:</b>	7.0 A	4.0 A	4.0 A	8.0 A	4.0 A	4.0 A
<b>Full Volts:</b>	58.8 V	58.8 V	56.7 V	28.8	43.2	57.6
<b>Float Volts</b>				27.0	40.5	54.0

If none of the presets are appropriate for your battery, then you have the option to add a custom profile as well with the *Create New Profile* screen at the end of the list. Custom profile creation is detailed in **Section 2.1.3**.

### 1.3 Charging Process

With just one profile active, the Satiator will start charging the battery whenever it is connected to a pack that isn't fully charged. If there is no battery attached, the display screen will say *CONNECT BATTERY* along with a summary of the charge profile. Once it detects a pack has been plugged in, then the charger will automatically start the charge process, and the display will show the charging status in real time. If *CONNECT BATTERY* still shows on the screen even after plugging in a pack, then a Force Start may be required, as described in **Section 5.1**.

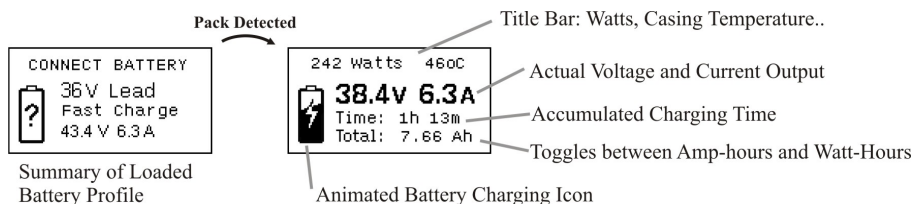

**Figure 6:** Display screen before battery connected and after start of charge cycle

The ability to see the actual amp-hours put into the pack can be of great value in understanding the health of a battery system and providing user confidence that their battery has received a full charge.

A title bar across the top provides additional information, including the output power, the casing temperature, and the target full charge voltage. The target voltage is useful to confirm that the correct profile is selected even after the charge process has begun. If a valid thermistor is connected to the charger plug, then the battery temperature will display on the title bar screen as well.

## 1.4 Terminating Charge

The charge process can be stopped by allowing the charge to finish, unplugging the battery, or by aborting charge.

### 1.4.1 Charge Complete

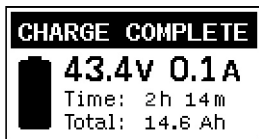

If the battery is left charging until reaching a full charge, the title bar will invert and say *CHARGE COMPLETE* allowing you to see from a distance that the cycle has finished. You will also see a summary of the elapsed charge time and amp-hours delivered to the battery.

**Figure 7:** On charge complete, voltage, time, and amp-hours still visible

With batteries that have a constant voltage end of charge mode, it is possible for small currents to continue flowing into the battery when the output says complete. *CHARGE COMPLETE* does not mean that the output is disabled, just that the full voltage has been reached and the charge current has decayed below the charge complete amperage threshold specified for the profile.

### 1.4.2 Pack Disconnect

You can also stop the charge by simply disconnecting the battery from the charger. Once the battery is removed, the screen will return to saying *CONNECT BATTERY*. At this point, it will continue to show the previous charge amp-hours on the display. If the battery is plugged back in within 5 seconds, then it will resume charging from the previous amp-hours and time, but if the delay is longer then it will start a new charge cycle with the amp-hours and time starting from zero again.



### 1.4.3 Abort Charge

Finally, it is possible to stop the charge process while charging is underway without unplugging the battery by pressing and holding the top button until *Abort Charge* pops up. The Satiator will return to the active profile list allowing you to scroll through and select a different charge profile.

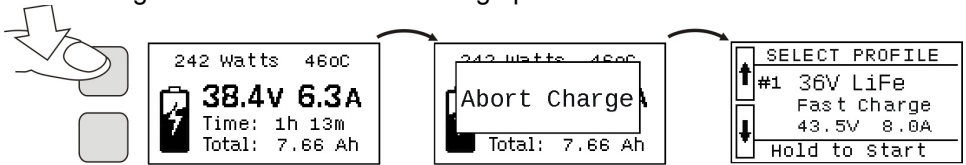

**Figure 8:** Aborting Charge. Hold top button to disable output and return to profile list

This feature is useful in the case of onboard installations where the battery terminals are permanently wired to the charger, and physically disconnecting the pack is difficult.

## 1.5 Additional Screens

During charging, a brief up/down button press will cycle through the statistics and graph displays to show additional information related both to the charge profile and the charge cycle that is underway.

### 1.5.1 Profile Statistics

36V Lithium stats	
Totals:	Avrgs:
728 Cyc	4.6 hr
114 kWh	728 Wh
4394 Ah	9.3 Ah

**Figure 9:** Each profile has its own life cycle and average statistics

The Satiator maintains a record of the lifetime charge history for each profile. This is visible from the 2<sup>nd</sup> display screen. On the left side are the total cycles, total kilowatt hours of energy, and total amp-hours of charge that the selected profile has seen. The column on the right shows the average watt-hours, amp-hours, and charge time for batteries on this profile.

This information is useful for understanding and recording the life cycle usage history of a battery pack, and can be valuable at quantifying battery longevity and ownership costs.

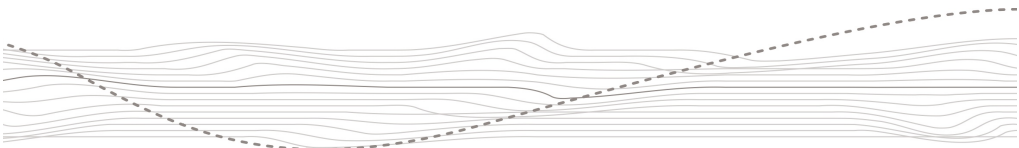

## 1.5.2 Charge Graph

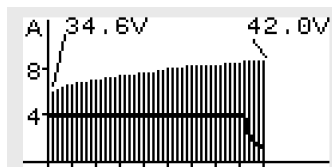
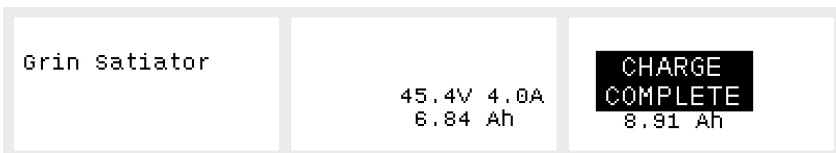

**Figure 10:** Charge Graph, starting and ending voltage shown on top. Amperage is bold line with scale on left

The 3<sup>rd</sup> display screen is a real-time graph of the current charge cycle. The battery voltage is shown as a solid infill, while the charge amperage is shown as a bold yellow line. The battery graphic is plotted versus time until charge complete is detected. Markers on the horizontal axis indicate the elapsed charge time and autoscale as the charge progresses.

## 1.5.3 Screen Saver

After several minutes with no button activity, the Satiator will go into a screen saver mode, where the current charge statistics and status are instead shown in a small text box that moves around the display. The screen saver will preserve the life and brightness of the OLED display pixels and ensures that they have a uniform intensity.

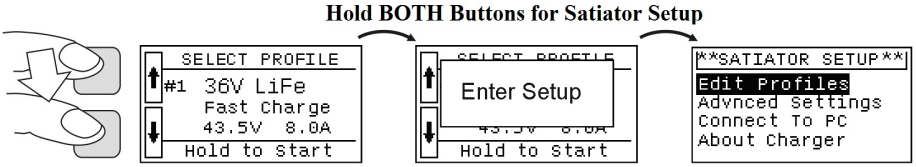

**Figure 11:** Screen saver views, with no battery connected (left), during charge (middle), after charge complete (right). The screen saver text will move around the display.

Pressing either button will exit the screen saver and return to the most recent display window.

## 2 Satiator Setup Menu

The Satiator setup menu allows you to edit the profile list, set advanced parameters, and connect the Satiator to a computer. The setup menu is accessed by pressing and holding down both buttons until you see the *Enter Setup* message.



**Figure 12:** Access the setup menu by pressing and holding both buttons. You cannot enter setup if the Satiator is actively charging a battery, in that case stop the charge process first.

The navigation of the setup menu with just two buttons will be very intuitive from the following principles:

- Briefly press the up or down buttons to cycle through a list or toggle through a value being edited.
- Press and hold the *lower* button to select an option.
- Press and hold the *upper* button to escape and go to the previous menu.

## 2.1 Editing the Profile List

The Satiator can store a large number of battery charging profiles in memory which are shown in the *Edit Profiles* list. However, only profiles that are marked as active will be available for charging. There are a number of preset profiles on the device which you can activate, and you can create new custom profiles and add them to the list as well. The circle on the left is a radio button indicating if the profile is active or not.

### 2.1.1 Activating New Profiles

If you scroll through the list and see another profile that you want, press and hold the lower button to edit it. Then press and hold the lower button again when *Active? - NO* is selected, and this will change to *YES*. After exiting the edit menu by selecting *Done*, you will return to the profile selection screen and will see that the active radio button is now checked.

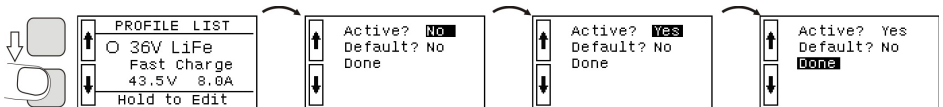

Radio Button Checked,  
Profile is Now Active

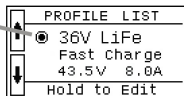
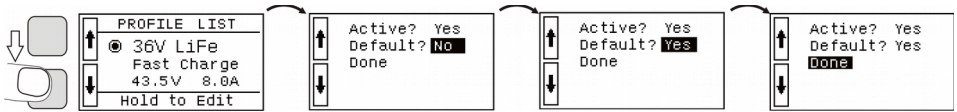

**Figure 13:** The active status of a profile is seen via the radio button

You can activate as many or as few profiles as you like. If you want a profile that isn't one of the presets, then you can create a number of custom profiles as described in **Section 2.1.3**.

### 2.1.2 Setting a Default Profile

In addition to activating or hiding profiles, you also have the ability to set one profile as your default. This state is indicated by the bold letter **D** under the active button.



**Figure 14:** Making a profile Default

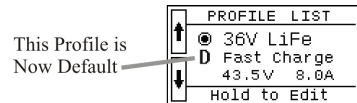

**Figure 15:** Letter "D" indicates default status

A default profile will be pre-selected when the

Satiator is turned on and will start charging when a battery is connected even with no button interaction, and requires careful consideration. See **Section 3.3** for more details on default profile usage.

### 2.1.3 Creating Custom Profiles

If a desired output is not available in the preset profiles, you can configure your own custom charger output with the *Create New Profile* screen at the end of the profile list.



**Figure 16:** Creating a new profile

You will then select between one of three basic classes of chemistry and associated charge algorithms. The up and down buttons will scroll through the list of parameters, and pressing and holding the lower button will allow you to

then edit the specific field one digit at a time. The list of parameters depends on the particular chemistry selected.

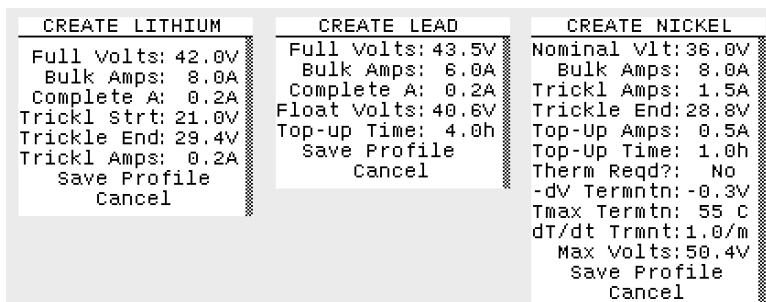

**Figure 17:** Full list of parameters available for custom Lithium, Lead and NiMH/NiCad batteries

Once all the parameters are set and *Save Profile* executed, then a new profile will be added to the profile list with the name *CUSTOM*, along with the general chemistry and charge voltage and current. A more detailed discussion of the specific parameters for each chemistry and their associated charge algorithm is included in Section 4.

### 2.1.4 Modifying Custom Profiles

Once a custom profile has been added to the list, it can be either edited or deleted from the list entirely using the button menu. Editing or deleting the preset profiles or personalizing the name of a custom profile is only possible with a computer connection. See **Section 2.3**

**Figure 18:** Custom profiles can have their parameters modified and can also be deleted from the list. But preset profiles cannot.

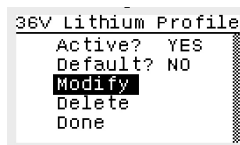

## 2.2 Advanced Settings

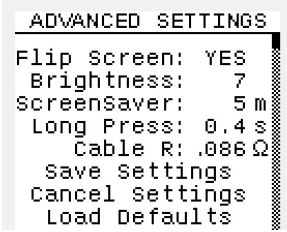

The Advanced Settings menu allows you to tweak global behaviors of the Satiator that are not associated with specific charge profiles.

**Figure 19:** Advanced Settings List has additional customization for charger behavior

### 2.2.1

## Flip Screen

By setting *Flip Screen* to *YES*, you can invert the orientation of the OLED module so that it reads upside down. This is useful in many certain applications where mounting convenience would dictate the charger installed hanging from a surface with the flange on the top instead of on the bottom. In this arrangement, the top and bottom buttons are also reversed.

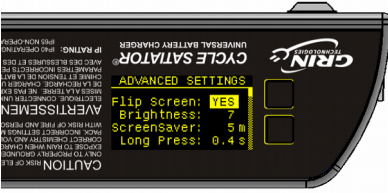

**Figure 20:** Screen rotated 180 degrees

## 2.2.2 Brightness

The brightness of the OLED display screen is adjustable from 1 (dimpest) to 9 (brightest). For outdoors legibility we recommend full brightness, but if it is mostly used indoors then a lower setting can be more than sufficient and will maximize the lifetime of the display.

## 2.2.3 Screen Saver

The time before the screen saver kicks in can be set from 0 to 240 minutes (4 hours). Setting this to 0 will disable the screen saver, but be aware that over time this can result in certain pixels becoming more faded than others.

## 2.2.4 Long Press

You can set the time required for a long button press to register, from 0.2 to 2 seconds. For dexterous users who are frequently changing their settings, a shorter time can speed up navigation through the menu system. A long value is

more appropriate for most situations to reduce likelihood of inadvertent changes and menu access.

### 2.2.5 Cable Resistance

The Satiator uses the resistance of the charging cable in order to account for cable losses and estimate more precisely the voltage at the terminals of the battery pack. The default value of 0.086 Ohm is correct for the included 1m charge cable, but if you lengthen or shorten the leads, or replace them with heavier gauge wire, then the cable resistance should be adjusted accordingly.

If the cable resistance is set too high, the Satiator may charge the battery to a higher voltage than intended. Too low a value (or zero), will simply result in a longer time spent in the constant voltage part of the charge termination. An incorrect cable resistance can also affect the battery temperature reading when using an external thermistor sensor, so with 3<sup>rd</sup> party charge cables we recommend setting this correctly based on the known wire gauge and length.

## 2.3 Connect to PC

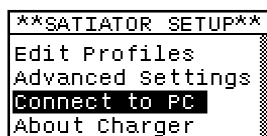
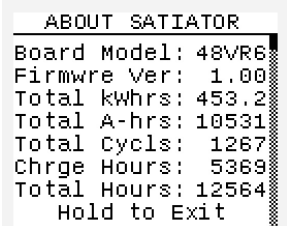

**Figure 21:** Access to Bootloader Mode from Setup Menu

The *Connect to PC* option in the Setup Menu allows you to put the Satiator into bootloader mode. This prepares the Satiator for computer communications either for installing new firmware or updating the charge profiles using the Satiator Software Suite. Once the Satiator is in bootloader mode, it is waiting for instructions from a computer connection and is no longer responsive to button presses. You must remove power from the Satiator and restart it to resume normal operation.

Bootloader mode can also be accessed by pressing and holding the lower button while the Satiator is being powered on, and the OLED display will remain blank rather than showing the splash display. This method is essential if an interruption during the firmware transfer leaves the Satiator only partially updated, and you can no longer navigate the setup menu.

## 2.4 About Charger



**Figure 22:** Full Satiator lifetime usage stats.

The final option in the Setup Menu allows you to see the details of your Satiator Device, such as the board hardware model and installed firmware, along with the total aggregate lifetime statistics for the unit.

While the statistics related to individual profiles can be lost when the profiles are deleted, the total lifetime statistics on a unit are always preserved and give an indication of the total device usage, both while charging batteries and even just when plugged in.

### 3 Charge Process with Multiple Profiles

With more than one profile active, care must be taken to make sure that the correct output mode is selected when charging a pack. The selection behavior depends whether or not a profile has been set as default:

#### 3.1 No Default Profile

Without a default profile, the Satiator will start up in the profile selection list. You need to scroll through the active profiles and select from available options the appropriate charge for the battery.

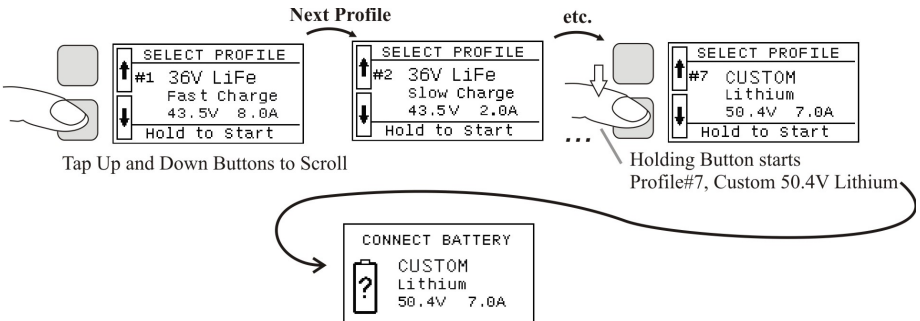

**Figure 23:** Starting a charge with multiple active profiles but no defaults

If a battery was plugged in at the time the profile was selected, then the charge will begin immediately. Otherwise, the charger will say *CONNECT BATTERY*, showing the profile summary and waiting for a pack to be detected.



When the *CONNECT BATTERY* text is displayed, it is possible to change active profiles by pressing and holding the top button to exit and repeat the selection process. Once the charge process has started, the charge profile is fixed and can only be changed to a different profile by first unplugging the battery or aborting charge (see 1.4.3)

### 3.2 With Default Profile

If you have a default profile, then the charger will always power on with that profile preselected. You can plug in the charger, connect the battery, and charging will automatically start with no button interaction.

To select one of the non-default profiles instead, press and hold the top button to escape back to the profile list before you connect the battery. You can then scroll through the active profiles and choose your desired one by holding the lower button.

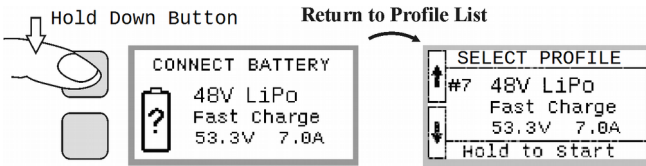

**Figure 24:** Hold top button to escape default profile and select another

### 3.3 Default Profile Usage

The use of a default profile is recommended whenever the charger is being used with only one type of battery pack. For instance, you may want a default which provides a standard overnight charge that only gives a 80% charge level at a modest current in order to maximize battery cycle life, but on occasion you may want to do a rapid 8A charge for quick top-up, or give it the full 100% charge when maximum range is needed. Since the one battery is compatible with all of these profiles, it is safe to have a default that will start charging automatically.

If you routinely switch between non-compatible batteries (different voltages or chemistries), then you should not use the default profile feature. That way you will always need to explicitly select the correct output for the battery being

charged, and will have less risk of plugging in and charging and incompatible battery. Charging with an incorrect charge profile for a pack can be benign or can be quite disastrous.

## 4 Charge Profile Details

When creating custom battery profiles it is important to understand the charge algorithm for the chemistry at hand. This is intended as an introductory explanation, but further research from your battery supplier would be recommended for creating a profile ideally suited for their packs.

### 4.1 Lithium

The lithium battery has a straightforward charge strategy. The battery is bulk charged at a constant current until the full charge voltage is reached. At that point, the charger maintains the full voltage while the charging current naturally decreases in an exponential decay. Once the current gets close to zero amps and falls below the *Complete Amps* threshold, the battery is full and the charger says Charge Complete.

If the lithium battery is deeply discharged but not so deep as to cause permanent cell damage (typically between 2.0-2.7 V/cell), then it is advisable to start the charging process at a low trickle current until a safe voltage is reached, and only then switch to the full bulk charge current. If the battery is deeply discharged to a point where any individual cell is dangerously low (typically less than 1.5-2.0V/cell), then a recharge should not be attempted. The low cells may appear to recover, but can exhibit reduced capacity, internal leakage currents, high impedance, and a propensity to catch fire.

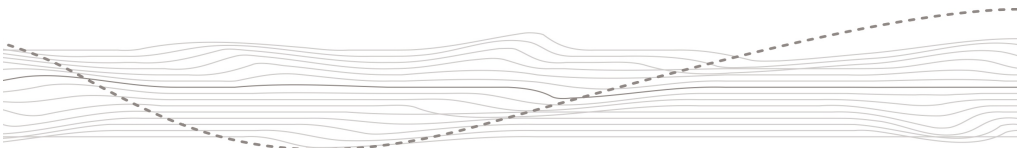

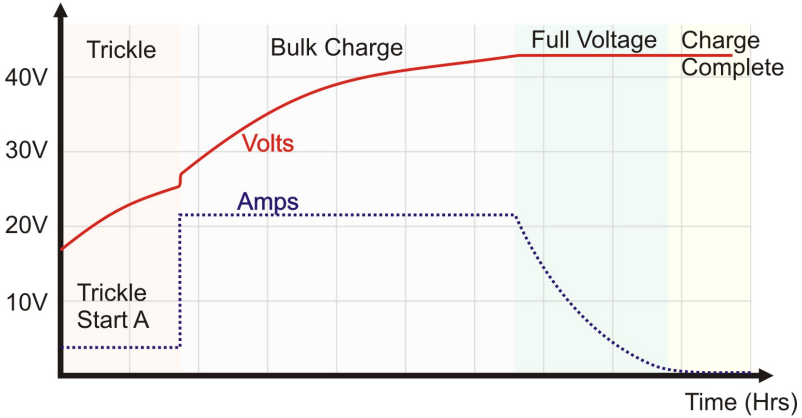

**Figure 25:** Charging Graph of a 36V Lithium Pack

When setting up a custom Lithium profile, you are required to set the Full Voltage and Bulk Charge current at the top of the list. The maximum charge current that your pack can support will depend on the cells, the onboard battery management circuit, and the connector plug. Most lithium cells can be charged at half their capacity (C/2) without problems, so a 12Ah pack would be fine with 6 amps, but can your connectors or protection circuit may limit you to lower levels.

The additional advanced parameters will be populated automatically to sensible default values, but can be tweaked if desired:

### Lithium Custom Profile Settings

<b>Basic Parameters:</b>	<b>Range</b>
Full Volts	12-63V
Bulk Amps	0.2-8.0A*

\*Charger will limit to 360W by reducing current

<b>Advanced Parameters:</b>	<b>Default</b>
Trickle Start Voltage	50% of Full Volts
Trickle Amps	0.2 A
Trickle End Voltage	70% of Full Volts
Complete Amps	0.2 A

Below the *Trickle Start Voltage*, the charger will not attempt to charge the pack as there is a risk that the cells are at a dangerously low level. If the voltage is higher than *Trickle Start Voltage* then it will charge at the smaller *Trickle Amps* current in order to gently bring the cells to a safe level. Once the voltage is at *Trickle End Voltage* level, then the charger will output the full bulk charge current until reaching the full charge voltage.

Most types of rechargeable lithium have a recommended full charge voltage of 4.2V / cell, although LiFePO4 are fully charged at a lower 3.5-3.8V, while certain newer chemistries can be charged up to 4.35 V. You should never exceed the manufacturer recommended full charge voltage, but in many cases you can greatly increase the cycle life on the cells by charging them to less than their recommended full charge voltage.

## 4.2 Lead Acid (SLA)

The charging characteristics of Lead Acid batteries are similar to Lithium batteries, except that after a full charge is complete, the output potential is reduced slightly to a float voltage. This prevents unnecessary reactions and electrolyte loss that can otherwise take place if the battery is held for too long at the full charge potential.

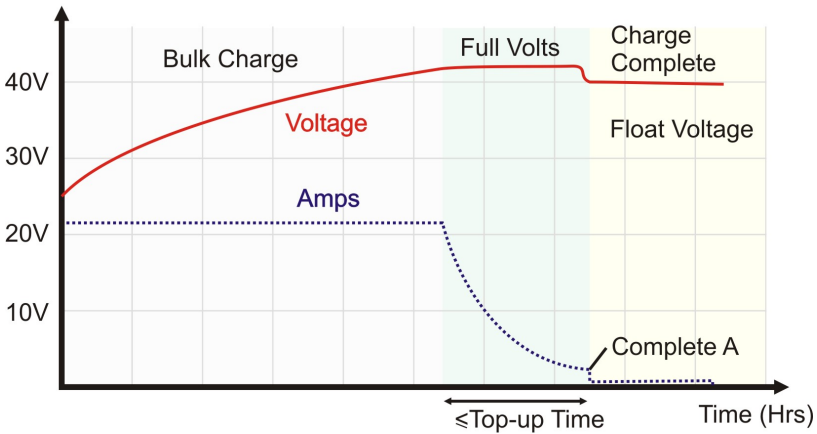

**Figure 26:** Charging Graph of 36V Lead Acid Battery

The lead acid profile parameters are setup as follows:

<b>Basic Parameters:</b>	<b>Range</b>
Full Volts	12-63V
Bulk Amps	0.2-8.0A*

<b>Advanced Parameters:</b>	<b>Default</b>
Float Volts	94% of FullV
Top-up Time	4 hrs
Complete Amps	0.2A

\* Charger will limit to 360W by reducing current if necessary

With lead acid batteries, it is usually recommended not to charge at more than a C/3 rate, so the *Bulk Amps* on a 12Ah lead battery shouldn't exceed 4 amps, and an 18Ah battery shouldn't exceed 6A, etc.

The charger will hold the full voltage until either the current drops below *Complete Amps*, or it has been held at the full voltage for *Top-up Time*. At either of these events, the charger output will drop to the float voltage, and the display will show *CHARGE COMPLETE*. To setup an equalizing charge profile for flooded lead acid batteries, you can set the full voltage about 10% higher than normal, and limit the *Top-up Time* to about 2hrs. The table below shows some typical voltage settings for 24V, 36V, and 48V lead acid packs at room temperature.

Reference Charge Voltages for Common Lead Acid Batteries

	24V	24V	36V	36V	48V	48V
	Sealed	Flooded	Sealed	Flooded	Sealed	Flooded
Full Voltage	28.0 V	29.6 V	42 V	44.4 V	56.0 V	59.2 V
Equalize FullV	N/A	31.0 V	N/A	46.5 V	N/A	62.0 V
Float Voltage	26.4 V	26.4 V	39.6 V	39.6 V	52.8 V	52.8 V

It is recommended to consult your battery manufacturer for their exact recommended charge voltage, especially in the case of Gel type sealed batteries that are more sensitive to overcharge. Similarly, care is needed when charging lead batteries at ambient temperatures above 30°C, as the charge voltages at higher temperatures also need to be reduced to prevent overcharging.

### 4.3 Nickel (NiCad or NiMH)

Nickel Cadmium and Nickel Metal Hydride batteries are unique in that their voltage rises and then falls again during the charge cycle, so the strategy of charging to a fixed voltage does not work.

Toward the end of the charge process, the battery temperature rises rapidly, and as the pack gets hotter the battery voltage eventually decreases. The end of

charge can be detected either by monitoring the battery temperature or by looking for the moment when the voltage starts to decrease, known as -DeltaV.

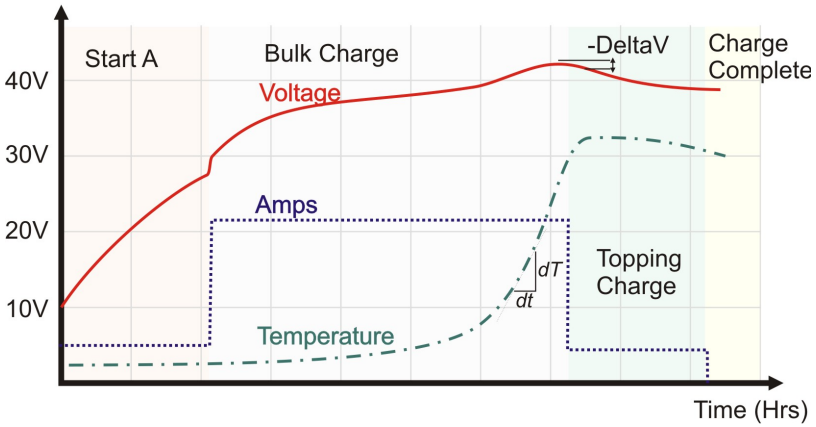

**Figure 27:** Charging Graph of 36V NiMH / NiCad Pack

Charging based on a temperature sensor is preferred and should always be used when a temperature sensor is available. After the temperature rise is detected, the battery is about 95% charged and the current is greatly reduced while charging is continued for a short amount of time to reach 100% charged status. This is known as the topping charge. If charging at full current is carried on to the -DeltaV point, then the pack has already been somewhat overcharged and there isn't as much need for this additional topping current.

The custom parameters for NiMH/NiCad packs are quite different than for the other chemistries. In the basic setup, the nominal rather than the full charge voltage is specified, and is mostly used for pre-populating the advanced parameters and generating the profile name.

**NiMH / NiCad Custom Profile Parameters:**

<b>Basic Parameters:</b>	<b>Range</b>
Nominal Volts	12-48 V
Bulk Amps	1.0-8.0 A*
Thermistor Required?	Yes / No

\*Charger will limit to 360W by reducing current if necessary

After any of the charge termination

<b>Advanced Parameters:</b>	<b>Default</b>
Trickle Amps	0.5 A
Trickle End	80% of Nominal Volts
Top-up Amps	0.5 A
Top-up Time	1.0 hr
-Delta V Termination	-1% of Nominal Volts
Tmax Termination	55°C
dT/dt Termination	1.0 deg / min
Max Volts	1.4*Nominal Volts

methods are detected, then the charger output current reduces to *TopUp Amps* for the fixed duration of *TopUp Time* in order to bring the pack to a 100% full charge.

We recommend a bulk charge current of at least 1/4 the battery capacity, as the end of charge indicators (Temperature Rise and Voltage Drop) are not pronounced at low charge currents. For instance, a 12Ah nickel battery should have at least a 3A bulk charging current.

The NiMH/NiCad profile does not run a continuous trickle current into the pack after charge is complete. This technique was common with NiCad batteries to counteract self-discharge and keep the battery 100% topped up, but with NiMH a continuous trickle for a long length of time will damage the cells. If you want a pack to be fully topped up prior to usage, then you should time your charging so that the charge will finish shortly before you will need the battery.

## 5 Additional Features and Details

### 5.1 Force Start

In some scenarios, you may have a battery attached to the charger but the charger still says *CONNECT BATTERY*. For instance, this can happen if the battery has been drained so low that the battery management system's (BMS's) protection circuit inside your pack has shut off and disabled the battery output. If there is no voltage on the battery terminals, the charger will be unaware that a pack has been plugged in.

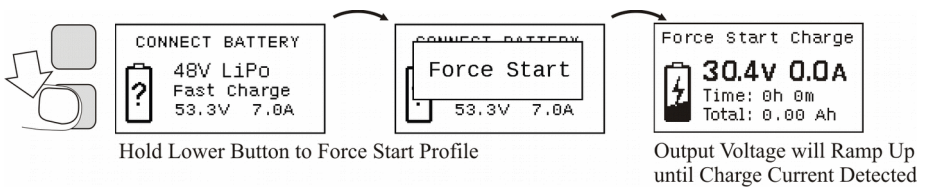

**Figure 28:** Force Start if battery not detected from tripped BMS

In this situation, pressing and holding the lower button on the *CONNECT BATTERY* screen will force the charger output to go active for a few seconds in order to begin a charge process. If it detects current flowing into the battery at a voltage higher than the start voltage for the selected profile, the normal charge process will begin.

## 5.2 Fault Conditions

There are several fault scenarios that you may encounter in using the Satiator.

### 5.2.1 Over Voltage

If the connected battery voltage is higher than the max voltage for the profile, then the display will produce a voltage too high error. This error screen will persist until the battery is removed

### 5.2.2 Short Circuit

If the Satiator senses that the output pins are either shorted together or have a reverse polarity voltage, then display will show a short circuit fault. This will clear once the short circuit or reverse polarity is removed from the output plugs. If you see a short circuit fault even when no battery is attached, then that could also be a sign that water or other conductive residue has contaminated the charging connector and is bridging the pins.

### 5.2.3 Power Stage Fault

In certain situations of abrupt load changes, it is possible for the Satiator's onboard over-current protection to trip. When this happens, the Satiator will not be able to output any current, so if you plug in a battery it will show the battery voltage correctly and attempt to charge but it will display 0 amps, and a short while later will display a power fault error. You can press the button to escape the fault screen and browse the charger menu, but the fault condition itself can only be reset by powering the Satiator off and on again.

### 5.2.4 OLED Screen Glitch

If the AC input to the Satiator is quickly interrupted and restored while the Satiator is charging a battery pack, then it is possible to corrupt and freeze the OLED display even though the Satiator is still charging fine in the background. Pressing either button will reset the display, as will waiting for it to enter screen saver mode.

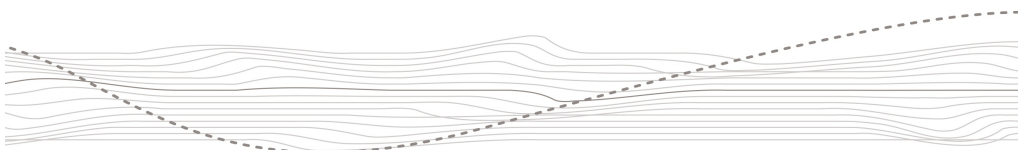



### 5.3 Cell Balancing

With lithium packs, it can happen that the battery stops charging abruptly because the BMS circuitry has tripped from a cell overvoltage fault. If the battery's management circuit does cell balancing, then this high voltage cell will be bled down to a release voltage and then the charging will resume again. This process can sometimes repeat many times, especially if the pack was largely unbalanced. Even though the charger says "Charge Complete", it will still resume the top up charges as the BMS circuitry allows so that the pack can fully balance out.

### 5.4 Thermal Rollback

The Cycle Satiator operates with much higher efficiency than standard ebike chargers (94-95% versus 80-85%). But it also packs twice the power output into a smaller footprint and eliminates active fan cooling, so the casing will still get quite warm during use. At full output power in a room temperature environment, it will typically reach about 60 degrees Celsius. This will feel hot to the touch but is not a cause for concern.

We recommend placing the charger in a location where it is exposed to free air in order to help dissipate this heat. If the charger is in an enclosed space (like a pannier bag), or is used in a hot environment and starts to overheat, then it will automatically scale back the output power so that the internal temperature does not get beyond 70 Celsius. This will not affect its ability to complete a charge cycle, but it will take longer as charging current will be reduced.

### 5.5 Orientation and Vent

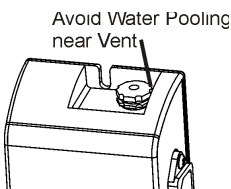

In general, the Cycle Satiator is easiest to operate when right side up, but it will function fine in any orientation. The only caveat is that the membrane vent on the input end of the charger should not be covered in water, so if it is mounted vertically care should be taken that it is not done in such a way that water pools around this vent area.

Figure 29: Membrane vent

## **5.6 Thermistor**

The 3rd pin of the XLR charge plug can be used in conjunction with a thermistor to ground for sensing pack temperature. This is recommended with NiMH and NiCad batteries. The charger expects a thermistor with 10kOhm resistance at room temperature, and a Beta constant between 3800-4000. This thermistor spec is common in industry with nickel based packs.

## **5.7 Upgrading Firmware**

The firmware and stock profile list on the Satiator can both be updated via an optional USB adapter plug that connects to the charge port and a computer. Details on re-flashing the firmware are explained in the help menu of the Satiator Software Suite, available for Windows, Mac OS, and Linux from <https://www.ebikes.ca/satiator/>

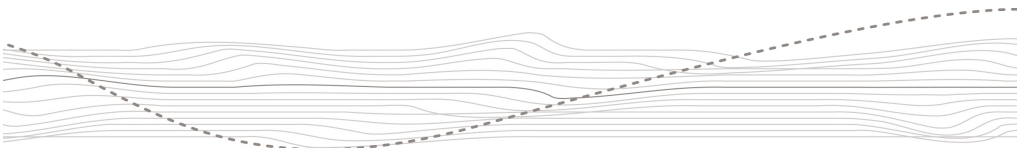

## 6 Complete Navigation Map

The diagram below shows the menu system and navigation layout for the User Interface, along with the conditions and/or button presses that cause the Satiator to go from one display to another.

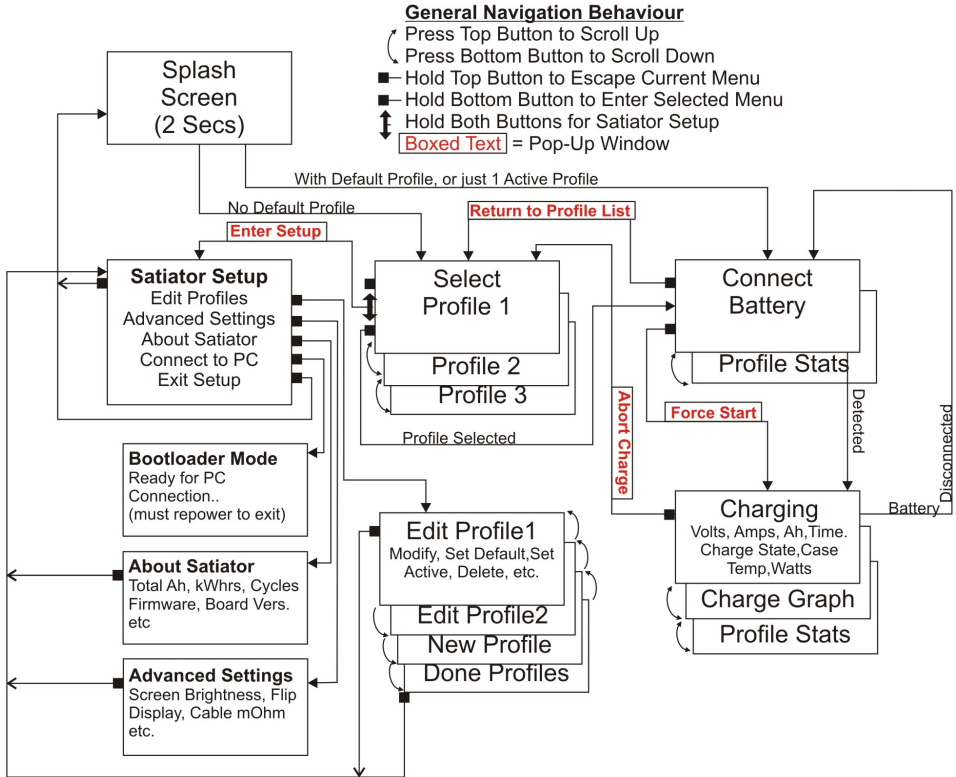

## 7 Specifications

### 7.1.1 Electrical

<b>Input Range</b>	100-240VAC 50-60Hz
<b>Max Output Range</b>	12-63V, 0-8A, 0-360 Watts (20-103V 0-5A for 72V Model)
<b>Operating Efficiency</b>	95% @ 230V, 94% @ 120V
<b>Power Factor</b>	>99%
<b>No Load AC Power</b>	<1 Watt
<b>Input/Output Isolation</b>	Reinforced Insulation, Tested to 3.75 kV
<b>Grounding</b>	Grounded Chassis, DC Output Floating
<b>Parasitic Drain from Battery</b>	<0.1 mA (600 kΩ Impedance, less than 1Ah / year)

### 7.1.2 Mechanical

<b>Dimensions</b>	237 x 78 x 48 mm
<b>Weight</b>	1.06 kg (1.33 kg with AC-DC cords)
<b>Vibration</b>	SAE J1455-1994 Category 2, UL458 / CSA 107.2
<b>Chassis Material</b>	Powdercoated Aluminum
<b>AC Input Connector</b>	IEC320-C14
<b>AC Input Cable</b>	2m with IEC320-C13 / NEMA-15 plugs
<b>DC Output Connector</b>	10A MULTICOMP/SINGATRON 2CT3002-W03400
<b>DC Output Cable</b>	1m with 3-Pin Neutrik XLR, (1=DC+, 2=DC-, 3=Signal)

### 7.1.3 Environmental

<b>Operating Temperature</b>	-30°C to +50°C (Output Power Derated >30°C)
<b>Storage Temperature</b>	-40°C to +60°C
<b>IP Rating</b>	IP40

### 7.1.4 Certifications

<b>Safety</b>	UL 1012, CSA - C22.2 No.107.2-01 (R2011) & UL1012 (Edition 8):2010, CE / IEC 60335-1/2-29
<b>Emissions</b>	FCC Part 15 B, EN55014, EN 61000-3-2, EN 61000-3-3
<b>Immunity</b>	EN 61000-4-2/-3/-4/-5/-6/-11
	Labtest Certification Inc., UL/CSA/CE Grin Technologies, CEC Small Battery Charger

### 7.1.5 Protection

<b>Output Short Circuit</b>	Requires manual power reset
<b>Reverse Battery</b>	Output disabled when reverse voltage detected. Internal fuse protection if output disable overridden
<b>Over-Voltage</b>	Output disabled if battery voltage exceeds Max Setpoint
<b>Under-Voltage</b>	Output disabled if battery voltage less than Min Setpoint
<b>Over-Current</b>	Charger output disabled if current exceeds Max Setpoint
<b>Over-Temperature</b>	Output current reduced to limit internal temp to <70°C