

GMAC Installation Guide

Rev 1.0



Thanks for your purchase of a GMAC motor kit! This motor has a number of unique features that set it aside from other direct drive and geared motor kits available on the market.

- **Locked Clutch:** Allows for effective and efficient regenerative braking down to very low wheel RPMs. When used with a Phaserunner controller for virtual freewheeling, the drag torque present when pedaling without assist can also be eliminated as well.
- **Round 10mm Axle:** By using a round 10mm axle, the hub fits properly inside the bicycle dropout slot and the disk rotor aligns properly with industry standard
- **Integrated Torque Arm:** An integrated torque arm on the splined portion of the motor axle allows for zero play installations to handle forwards and regen torques without any slop. It also eliminates torque transmission and spreading forces on the dropout slot and transfers this force to a securely to the chainstays with a pair of hose clamps.
- **Side Cable Exit:** Better protects electrical wire from damage and provides flexibility for axle hardware changes.

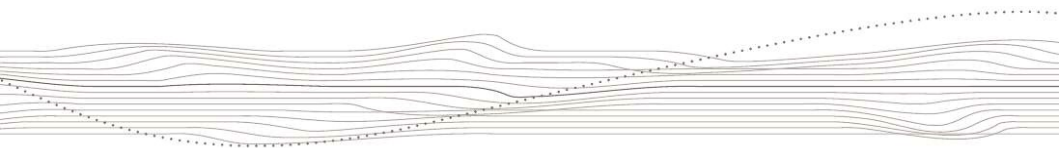

GMAC Installation Guide

Rev 1.0



Tools needed:

Adjustable Wrench (10mm-17mm) - T20 torx screwdriver - M4 Allen Key

Machined Torque Arm Components:

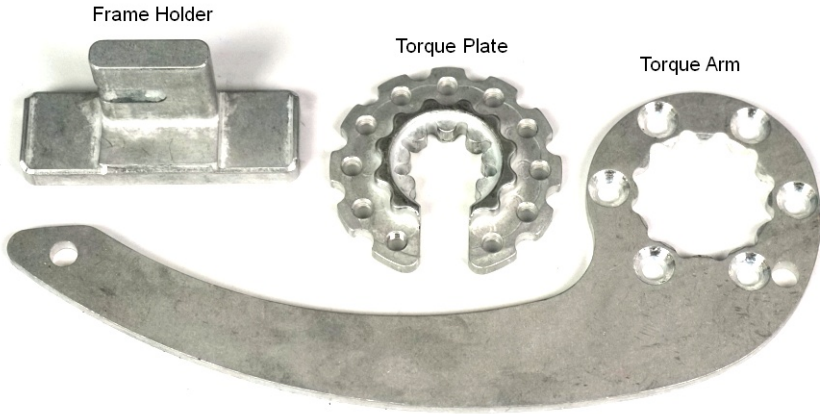

Torque Plate Installation:

- If the motor requires a disk rotor, remove the installed torque plate to access disk rotor bolts. This may require prying with a screwdriver.
- Remove the disk spacer ring and replace it with the disk rotor.
- Reposition the torque plate over the axle splines, aligning the slot with the wire exit.
- Align the splines of the axle into the torque plate and press or tap the plate down until the splines protrude past the plate.

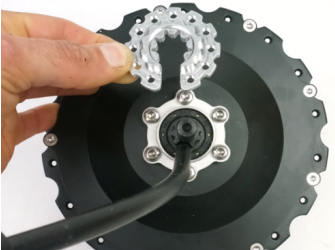

GMAC Installation Guide

Rev 1.0



Torque Arm Installation:

Once the torque plate is installed, the torque arm should be installed into the neutral position as shown in the photo below. The system is meant to be installed such that the wire exit passes through the dropout slot on the bicycle frame, following the arrow in the diagram below.

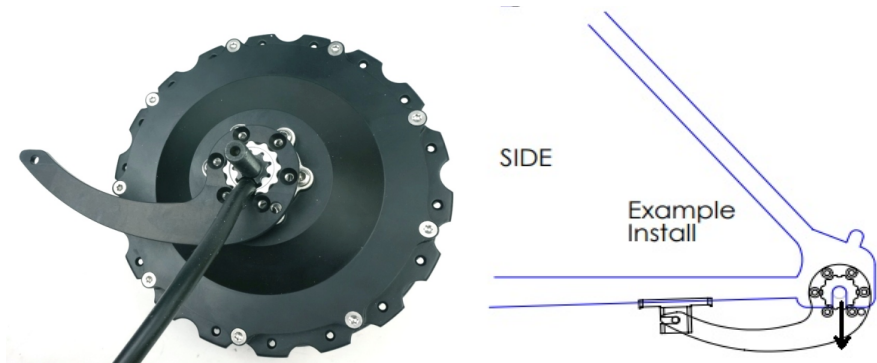

If your frame has either a different angle on the dropouts, for example a horizontal dropout, you would need to remove the torque arm from the torque plate and rotate it such that the wire exit matches the angle of the dropout when the torque arm is rotated to meet the frame's chain stay. The splined interface allows for rotation between the torque arm and torque plate in 30 degree steps.

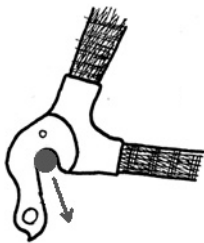

vertical dropouts



horizontal dropouts

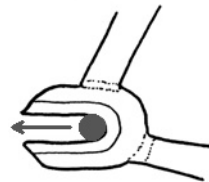

track ends

Once the arm orientation is set to then it can be screwed tightly in place with either 5 or 6 of the countersunk M4 Fasteners using a T20 Torx Driver.

GMAC Installation Guide

Rev 1.0



The final stage is to align the Frame Holder for the best fit to the torque arm. The holder is made deliberately asymmetric so that it can be flipped 180 degrees in order to accommodate a wide range of frame geometries with 4 different alignment planes. Select the one that fits most closely with the plane of the torque arm, and then secure them together with the M5 bolt and flanged nyloc nut.

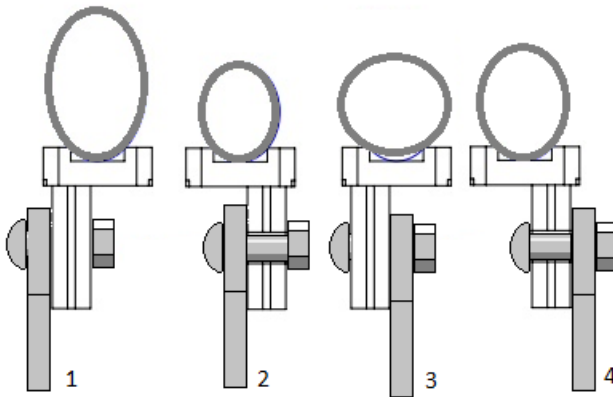

Finally, secure the Frame Holder to the chainstay using the two hose-clamps. The black shrink tubing can be installed over each band in order to protect the paint finish and have a more discrete look.

The M10 washers and axle nuts must also be installed and thoroughly tightened on the GMAC motor axle. We recommend tightening to at least 40 Nm (30 ft-lb).

